

# Epoch Design, LLC

Congratulations on the purchase of your Alexa Solid Hardwood Bunk Bed. This bed has been crafted to the highest standards of quality and safety and will give you many years of enjoyment and practical use. Your Solid Hardwood Bunk Bed can be separated into two individual twin beds when the need arises for separate sleeping configurations.

Since this bed is a natural wood product there will be variations in color and grain, and minor checking may occur. This is normal and does not compromise the integrity of your bed. In fact, variation in character of solid hardwood is integral to the beauty and appeal of hardwood furniture, and distinguishes it from prefabricated, synthetic and composite materials.

Several basic safety considerations must be adhered to when using this bunk bed.

## **TO HELP PREVENT serious or fatal injury from entrapment or falls:**

- Never allow a child under 6 years on upper bunk.
- Always use the recommended size mattress or mattress support(standard twin 38"X74")(96.5cmX188cm), or both, to help prevent the likelihood of entrapment or falls.
- Ensure thickness of mattress does not exceed 9 inches(22.9cm).
- Mattress must be at least 5 inches(127mm) below upper edge of guardrails.
- Always use guardrails on both sides of upper bunk.
- Do not allow horseplay on or under bed(s) and prohibit jumping on the bed.
- Prohibit more than one person on upper bunk.
- Always use the ladder for entering and leaving upper bunk.
- If the bunk will be placed next to a wall, the guardrail that runs the full length of the bed should be placed against the wall to prevent entrapment between the bed and the wall.
- Follow the information on the warnings appearing the upper bunk end structure and on the carton. Do not remove warning label from bed.
- Periodically check and ensure that the guardrail, ladder and other components are in their proper position, free from damage and that all connectors are tight.
- Do not use substitute parts. Contact Mfg. or dealer for replacement parts.
- The use of water or sleep flotation mattress is prohibited.
- Keep these instructions for future reference.
- Use of a night light may provide added safety precaution for a child using the upper bunk.

On this insert you will find a list of the hardware and bunk bed parts necessary for assembly, as well as detailed instructions. Assembly is quite simple and requires only a flat head screwdriver and a phillips head screwdriver. The use of a power drill with phillips head attachment is helpful but not necessary. Assembly will be most easily accomplished if you take the time to carefully sort the hardware and familiarize yourself with the function of each piece.

If you need assistance with assembly, part replacement or any other matter, contact the toll-free Epoch Design Service Center from anywhere in the Continental United States, Monday through Friday, 10AM - 5PM Pacific Standard Time at 1-800-589-7990. You may also fax your request or comments to 425-284-0885 and a service representative will respond.

**Thank you and Enjoy**

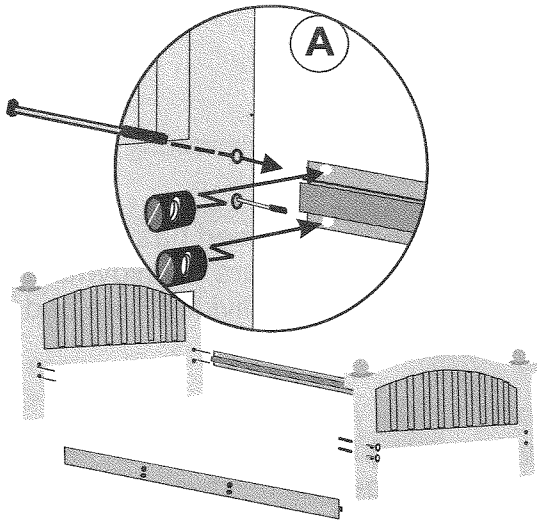

1) To assemble upper bunk, attach short end boards to upper bunk side rails. The side rails used on upper bunk have pre-drilled holes for safety rail attachment. Insert barrel nuts into side rails. Insert 100mm bolts through end boards and into barrel nuts (See Diagram A).

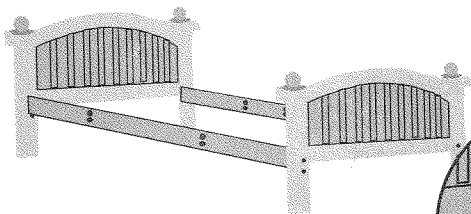

2) Tighten 100mm bolts with hex key provided (See Diagram B).

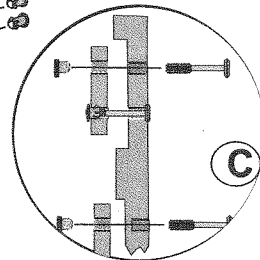
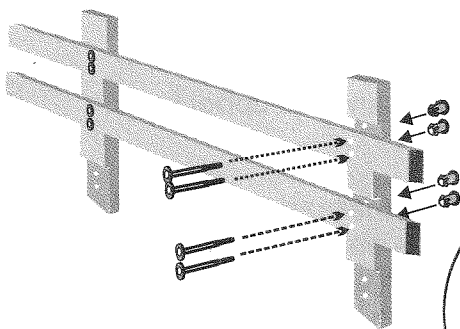
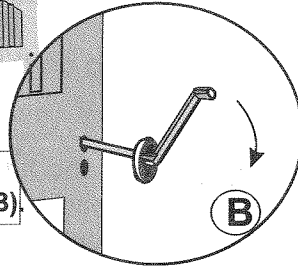

3) Attach the two long safety rails to the unassembled upright supports using eight 50 mm bolts and eight propel nuts. Tighten with hex key (See Diagrams C).

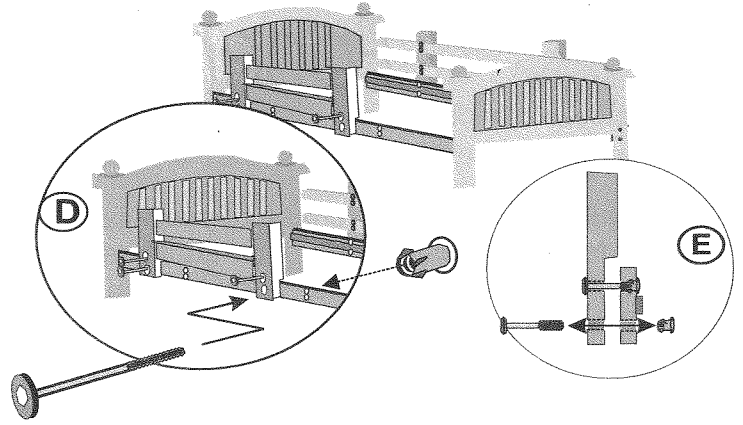

4) Attach the long and shorter safety rails to each side rail of the upper bunk using eight 50 mm bolts and eight propel nuts (See Diagrams D & E). The longer rail will be on the side of the bunk which is opposite the ladder. The shorter rail will be used to access the bunk with the ladder.

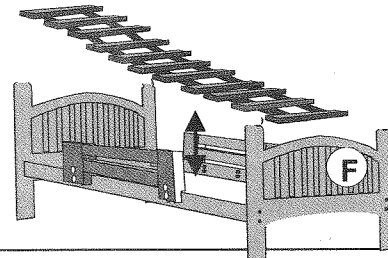

5) Unroll slat bundle (strap side down) onto side rail ledges from end to end (See Diagram F).

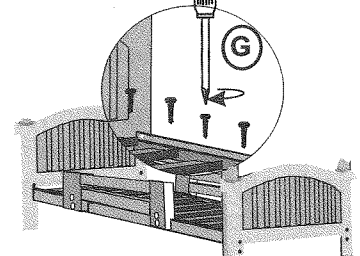

6) Attach slats to side rail ledge with slat screws using a Phillips head screwdriver (See Diagram G). A power screwdriver comes in handy here.

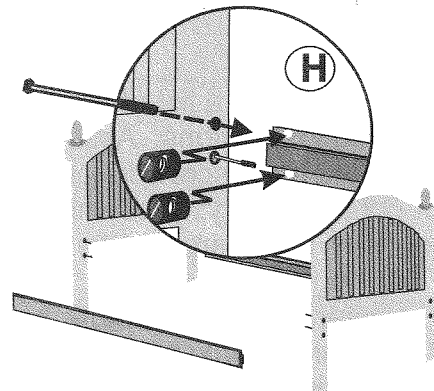

7) To assemble lower bunk, repeat procedure used for upper bunk using taller end boards. (See Diagram H).

Have a question??.. need a part ASAP??..1-800-589-7990

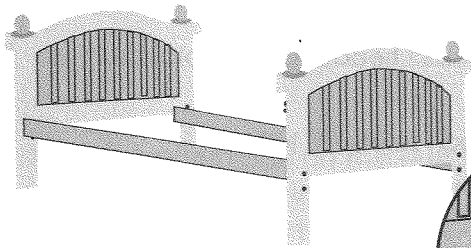

**8)** Tighten 100mm bolts to barrel nuts with hex key (See Diagram I).

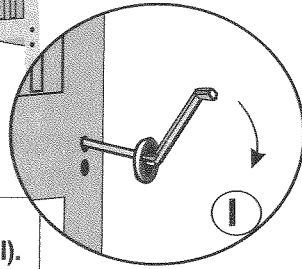

**11)** Place the upper bunk on top of the lower bunk, inserting bunk connector pin into each of the four corner posts (See Diagram L).

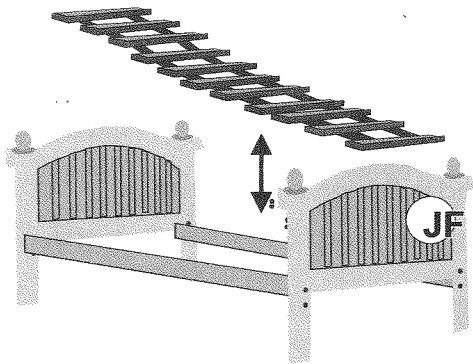
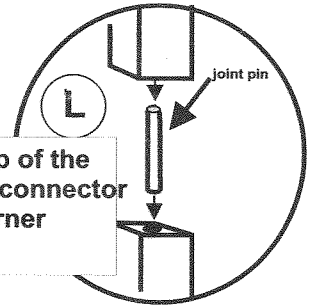

**9)** Unroll slat bundle (strap side down) onto ledges of side rails (See Diagram J).

**12)** Attach ladder hook to the top back sides of ladder using ladder hook screws (See Diagram M).

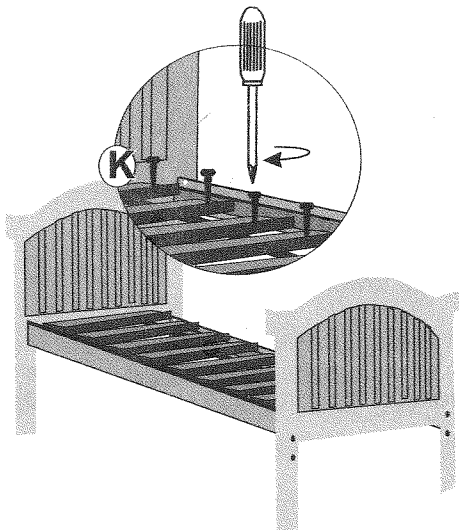
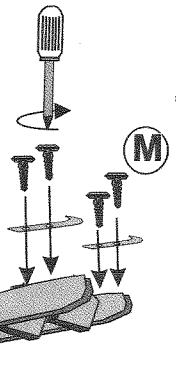



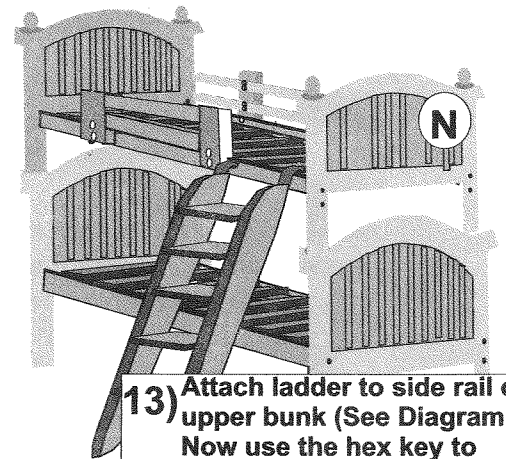





**10)** Attach slat bundle to side rail ledges with slat screws using a phillips head screwdriver. A power screwdriver comes in handy here (See Diagram K).









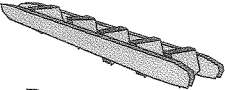
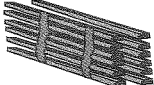

**13)** Attach ladder to side rail of upper bunk (See Diagram N). Now use the hex key to retighten all bolts so that bunk bed assembly is rigid. It may be necessary to retighten bunk after wood has acclimated to your weather region.

Have a question??.. need a part ASAP??..1-800-589-7990

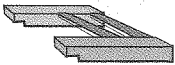
quantity		hardware list	use
16		100 mm bolt	Used to connect headboard & footboard to side rails
16		50 mm bolt	Used to attach safety rail to bunk
16		barrel nut	Used to secure bolts
16		propel nuts	Used to attach safety rail to side rail with 50 mm bolt
4		upper/lower bunk connector pin	Used to connect lower bunk to upper bunk
64		slat screw	Used to secure slats to rail
4		ladder hook screw	Used to attach hooks to ladder
2		ladder hook	Used to secure ladder to bed
1		hex key	Tool used to tighten bolt hardware

## bunk bed parts

2		Side rails which connect end boards on the lower bunk
2		Side rails which connect end boards on the upper bunk
1		Ladder which attaches to upper side rail for entry to upper bunk
2		Slat bundles which rest on side rails, strap side down, and support mattresses
2		Shorter end boards for use on the upper bunk
2		Taller end boards for use on the lower bunk
1		Preassembled short safety rail for attachment to side rail on upper bunk (ladder access side)
2		Long safety rails for attachment to upright support on upper bunk (wall side of bunk)
2		Upright support for attachment of long safety rails to upper bunk
4		Ornamental wood balls for use on headboards when bunks are separate

Have a question??.. need a part ASAP??..1-800-589-7990